

PLAN

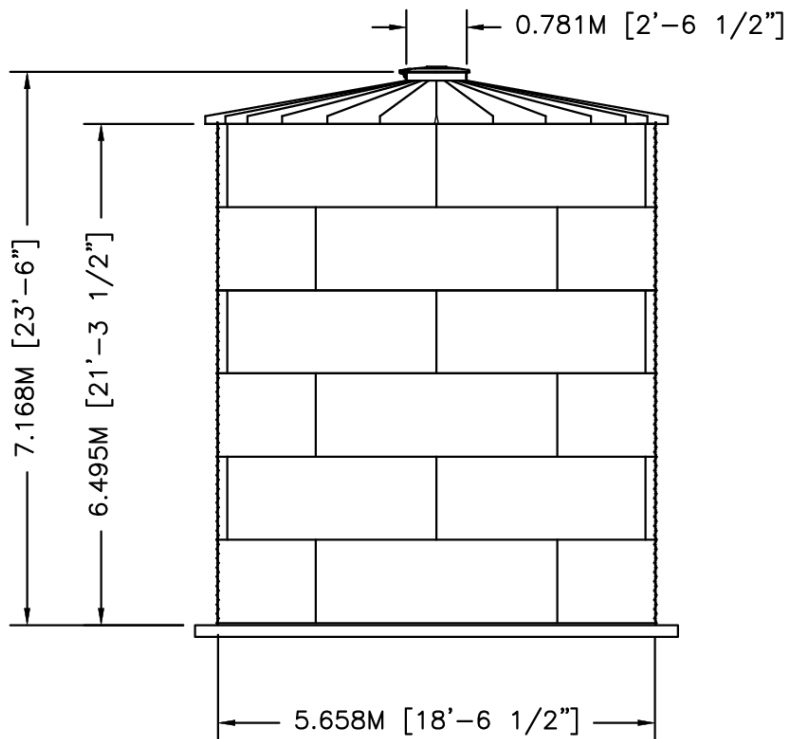

ELEVATION

	BY	DATE	TITLE	
DWN	XXX	XX/XX/XX	WTU06-06 30"PR 10DEG V-RIB	
CKD			NOMINAL CAPACITY - 160.271 M3 [42,339 GAL]	
ENG			DWG. NO. SCT1806-LVR WTU06-06	REV. NO.
SIZE: A		SCALE: 1/8"=1'-0"		SHEET 1 OF 1

